

# Operating Manual

Easypell®  
16 – 32kW

---

ENGLISH

---



Title: Operating Manual Easypell® 16 — 32kW

Article number: 200013\_EN 1.2

Version valid  
from: 09/2015

Approved: Wohlinger Christian

Distributed in UK by:

**Organic Energy (UK) Ltd**

Severn Road, Welshpool

Powys, SY21 7AZ

Tel. 01938 530 070

mail: [info@organicenergy.co.uk](mailto:info@organicenergy.co.uk)

[www.organicenergy.co.uk](http://www.organicenergy.co.uk)



---

<b>1 Dear Customer</b> .....	<b>4</b>
<b>2 Types of safety warning sign</b> .....	<b>5</b>
<b>3 Warnings and safety instructions</b> .....	<b>6</b>
3.1 Basic safety instructions .....	6
3.2 Warning signs.....	6
3.3 What to do in an emergency.....	7
<b>4 Prerequisites for installing a pellet boiler</b> .....	<b>8</b>
4.1 Central heating room .....	8
4.2 Safety systems .....	9
4.3 Operation of a pellet boiler with an existing boiler.....	9
<b>5 Fuel</b> .....	<b>10</b>
5.1 Specification for high quality pellets as per EN 14961-2, class A1.....	10
<b>6 The Easypell</b> .....	<b>11</b>
<b>7 Maintenance and servicing</b> .....	<b>13</b>
7.1 Maintenance .....	13
7.2 Emptying the ash pan .....	13
7.3 Cleaning the boiler every year.....	15
<b>8 Operating the heating system</b> .....	<b>19</b>
8.1 Description of the control panel .....	19
<b>9 User controls and their function</b> .....	<b>20</b>
9.1 Selecting the set DHW temperature.....	22
9.1.1 Setting the time program for DHW heating .....	23
9.1.2 Setting the time.....	26
9.1.3 Status display .....	27
9.2 Setting the boiler heating period .....	28
9.2.1 Setting the time.....	31
9.2.2 Status display .....	32
<b>10 Malfunctions</b> .....	<b>33</b>
10.1 Malfunctions - what to do.....	33
10.2 Fault texts .....	33
10.3 Maintenance intervals.....	37
10.4 Repairs .....	37
10.5 Checking the central heating room and storage room .....	37

# 1 Dear Customer

- This manual is intended to help you operate the product safely, properly and economically.
- Please read this manual right through and take note of the safety warnings.
- Keep all documentation supplied with this unit in a safe place for future reference.  
Please pass on the documentation to the new user if you decide to part with the unit at a later date.
- Please contact your authorised dealer if you have any questions.

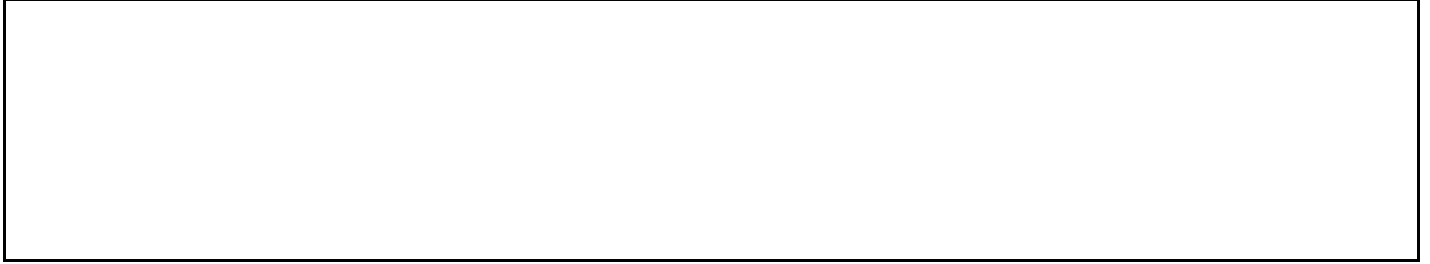

## 2 Types of safety warning sign

The warning signs use the following symbols and texts.

### Types of safety warning sign

1. Risk of injury
2. Consequences of risk
3. Avoiding risk

#### 1. Risk of injury:

Danger - indicates a situation that could lead to death or life-threatening injury.



Warning - indicates a situation that could lead life-threatening or serious injury.



Caution - indicates a situation that could lead to injury.



Note - indicates a situation that could lead to property damage.



#### 2. Consequences of risk

Effects and consequences resulting from incorrect operation.

#### 3. Avoiding risk

Observing safety instructions ensures that the heating system is operated safely



## 3 Warnings and safety instructions

Observing safety instructions ensures that the heating system is operated safely.

### 3.1 Basic safety instructions

- Never get yourself into danger; give own safety the utmost priority.
- Keep children away from the central heating room and storage room.
- Observe all safety warnings on the boiler and in this user manual.
- Observe all instructions relating to maintenance, servicing and cleaning.
- The pellet heating system may only be installed and started up for the first time by an authorised plumber. Professional installation and start up is the prerequisite for safe and economical operation.
- Never make any changes to the heating system or flue gas system.
- Never close or remove safety valves.

### 3.2 Warning signs



#### DANGER

##### Risk of poisoning

Make sure that the pellet boiler is supplied with sufficient combustion air.

The openings in the combustion air inlet must never be partially or completely closed.

Ventilation systems, central vacuum cleaning systems, extractor fans, air conditioning systems, flue gas blowers, dryers or similar equipment must never be allowed to draw air from the central heating room and cause a drop in pressure.

The boiler must be connected tight to the chimney using a flue gas tube.

Clean the chimney and the flue gas tube at regular intervals.

The central heating room and pellet storage room must be sufficiently supplied with air and ventilated.

Before entering the storage room it must be ventilated with sufficient air and the heating system switched off.



#### DANGER

##### Risk of electric shock

Switch off the system before performing work on the boiler.



#### DANGER

##### Risk of explosion

Never burn petrol, diesel, engine oil or other explosive materials.

Never use liquids or chemicals to ignite the pellets.

Switch off the heating system before filling the storage room.

**DANGER****Risk of fire**

Do not store any flammable materials in the central heating room. Do not hang out any washing in the central heating room.  
Always close the boiler door.

**WARNING****Risk of burns**

Do not touch the flue spigot or the flue gas tube.  
Do not reach into the ash chamber.  
Use gloves to empty the ash box.  
Do not clean the boiler until it has been allowed to cool down.

**CAUTION****Risk of cut injuries due to sharp edges.**

Use gloves for performing all work on the boiler.

**NOTICE****Damage to property**

Heat the pellet heating system using pellets that comply with EN 14961-2 class A1 and A2 only.

**NOTICE****Damage to property**

Do not use the heating system if it, or any of its components, come into contact with water.  
If water damage occurs, have the heating system checked by a service technician and have any damaged parts replaced.

### 3.3 What to do in an emergency

**DANGER****Risk to life**

Never get yourself into danger; give own safety the utmost priority.

**What to do in the event of a fire**

- Switch off the heating system.
- Call the fire brigade
- Use approved fire extinguishers (fire protection class ABC).

**What to do if you smell smoke**

- Switch off the heating system.
- Close the doors leading to living areas.
- Ventilate the central heating room.

## 4 Prerequisites for installing a pellet boiler

You must fulfill the following conditions before operating a fully automatic pellet boiler.

### 4.1 Central heating room

The pellet boiler is installed in the central heating room.

#### 1. Safety instructions for the heating room

	<b>DANGER</b>
<p><b>Risk of fire</b>            Do not store flammable materials or liquids in the vicinity of the pellet boiler.            Do not permit unauthorised persons to enter the central heating room - children are to be kept out.            Always close the boiler door.</p>	

#### 2. Air supply and ventilation of central heating room

The central heating room must be fitted with air supply and ventilation openings (at least 200cm<sup>2</sup>). Legislation in your country must be observed.

#### 3. Combustion air supply

The pellet boiler needs a supply of combustion air.

Never operate the pellet boiler if the air intake openings are partially or completely closed.

Contaminated combustion air can cause damage to the pellet boiler. Never store or use cleaning detergents containing chlorine, nitrobenzene or halogen in the room where the heating system is installed, if combustion air is drawn directly from the room.

Do not hang out washing in the central heating room.

Prevent dust from collecting at the combustion air intake to the pellet boiler.

#### 4. Damage due to frost and humid air

The central heating room must be frost-proof to ensure trouble-free operation of the heating system. The temperature of the central heating room must not fall below -3°C and must not exceed +30°C. The air humidity in the central heating room must not exceed 70%.

#### 5. Danger for animals

Make sure that household pets and other small animals cannot enter the central heating room. Fit mesh over any openings.

#### 6. Flooding

If there is a risk of flooding, switch off the pellet boiler in good time and disconnect from the power supply before water enters the central heating room. You must have all components that come into contact with water replaced, before you start up the pellet boiler again.

#### 7. Cleaning

Clean the flue gas tube and chimney regularly.

<b>NOTICE</b>
<p><b>Oxidation of chimney</b>            Do not use metal brushes to clean chimneys made of stainless steel.            Legislation in your country must be observed.</p>



## 4.2 Safety systems

The following safety measures are the prerequisite for safe operation of your system.

### Emergency stop switch

Every heating system must be able to be switched off with an Emergency Stop switch. The Emergency Stop switch must be inside the central heating room.



### Safety valve

The hydraulic system must be equipped with a safety valve. This valve opens when the pressure inside the heating system increases to max. 3 bar. The safety valve must:

- be installed at the highest point of the boiler,
- must not be locked,
- and must be within 1 metre of the boiler.



### Safety temperature sensor

The pellet boiler is equipped with a safety temperature sensor. This is located on the pellet boiler. If the boiler temperature exceeds 95°C then the heating system switches off.



### Expansion tank

All heating systems must be equipped with a pressurised expansion tank. The plumber or heating system installer must dimension the expansion tanks according to the dimensions of the hydraulic system.



## NOTICE

### Starting up

Starting up for the first time has to be performed only by an authorized service technician.

## 4.3 Operation of a pellet boiler with an existing boiler

There are different regulations in the different European countries. Please mind the prescription of your country.

## 5 Fuel

Wood pellets are natural wood (dried sawdust or waste from machining) that has been formed into pellets under high pressure. They have a very low moisture content and very high calorific value. The manufacture of wood pellets is regulated by European standard EN 14961-2.

### 5.1 Specification for high quality pellets as per EN 14961-2, class A1

Calorific value	4,6 – 5,3 kWh/kg 16,5 – 19 MJ/kg
Loose density	min. 600 kg/m <sup>3</sup>
Water content	max. 10%
Ash content	max. 0.7%
Ash melting point	at least 1200°C
Length	max. 40 mm
Diameter	6 - 8 mm
Fine material	max. 1%
Contents	100% natural wood

### NOTICE

The heating system is suitable only for pellets of natural wood that comply with standard EN 14961-2 class A1 with a diameter of 6 - 8 mm. Using non-pelletised fuels or pellets that are not manufactured from natural wood will lead to the warranty becoming void and will cause damage to the pellet boiler and the chimney.

Use only quality pellets from Austrian standard approved, DINplus **or** ENplus approved manufacturers. For more information on fuels, please visit the website:

**[www.oekofen.com](http://www.oekofen.com)**

## 6 The Easypell

### Easypell types and power ratings

Eco Engineering offers the Easypell with the following power ratings: 16, 20, 25 and 32kW.

#### Note:

Refer to the data plate for the power rating of your Easypell. The data plate is located on the rear side of the boiler. Here you find the type designation, manufacturer's serial number and year of build.

### Key components of the Easypell

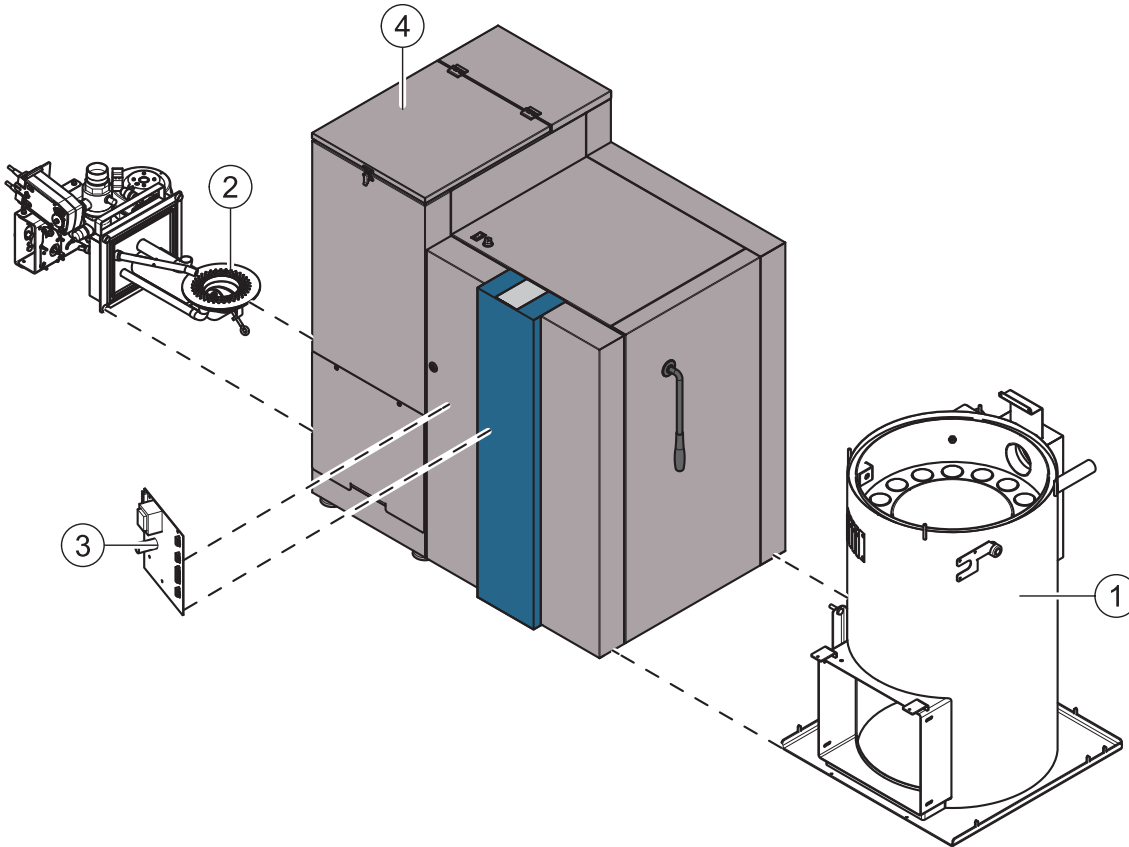

1	Boiler (heat exchanger)	3	Boiler controller
2	Burner	4	Pellet hopper

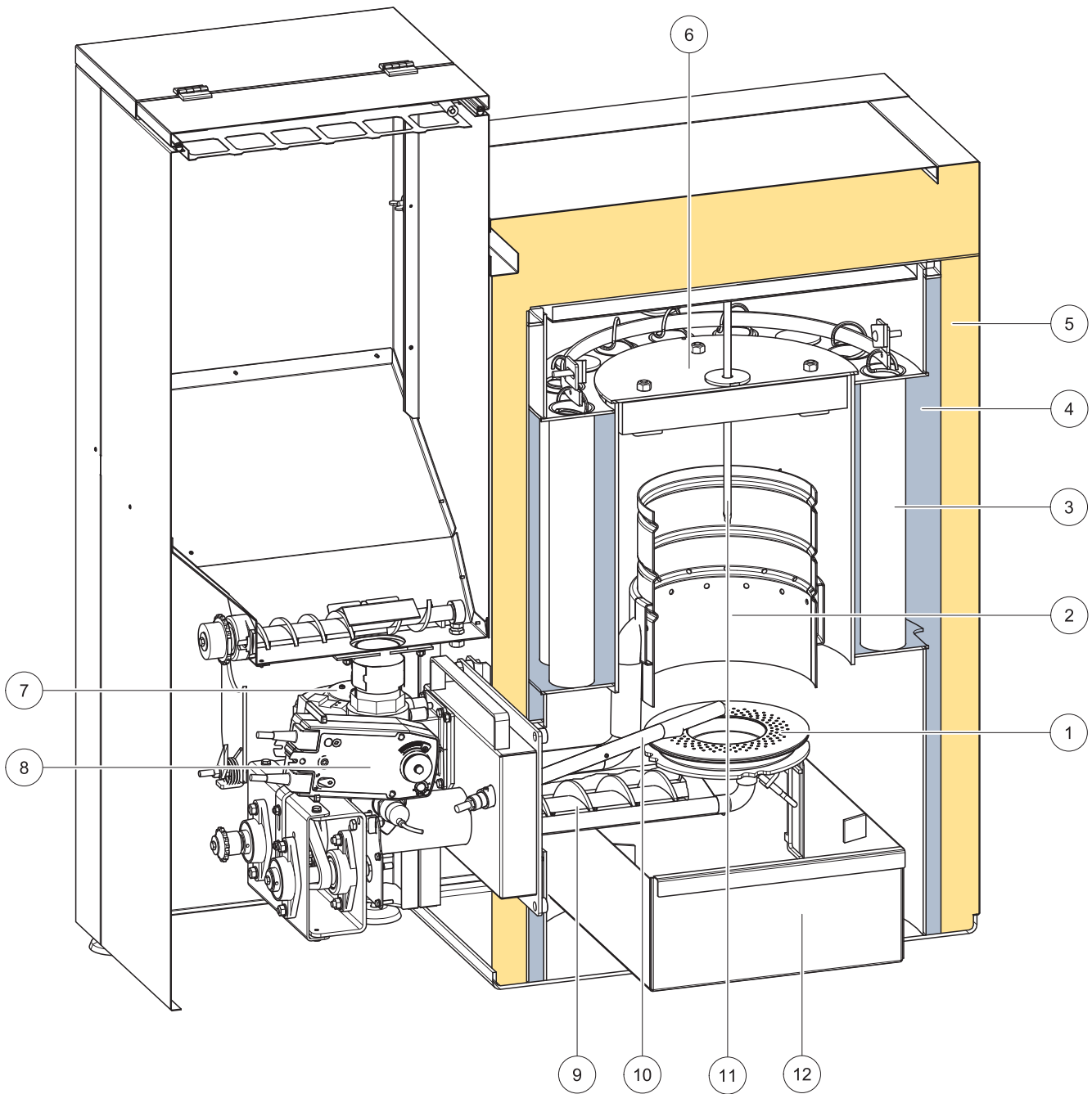

1	Burner plate	7	Suction fan
2	Flame tube	8	Anti-blowback system
3	Heat exchanger	9	Burner auger
4	Boiler water	10	Electronic ignition
5	Boiler insulation	11	Combustion chamber sensor
6	Combustion chamber cover	12	Ash box

# 7 Maintenance and servicing

Regular checks of the pellet heating system are a prerequisite for reliable, efficient and environment-friendly operation.

## 7.1 Maintenance

Maintenance, boiler cleaning and cleaning of flue gas connection are necessary at least once a year. Pellets which produces tendentially more slagging (ash melting point <1300 ° C) and pellets with higher bulk density (> 650kg) leads to additional cleaning of the burner plate at regular intervals.

## 7.2 Emptying the ash pan

	<b>CAUTION</b>
Risk of burns Use gloves. Do not touch the boiler vessel.	

	<b>DANGER</b>
Risk of fire Do not empty ash into a flammable container. Do not empty ash onto flammable floors or materials. Do not dispose of ash until it has completely cooled down.	

**Note:**

Check the level of the ash box and empty it at regular intervals (at least every 2 weeks).

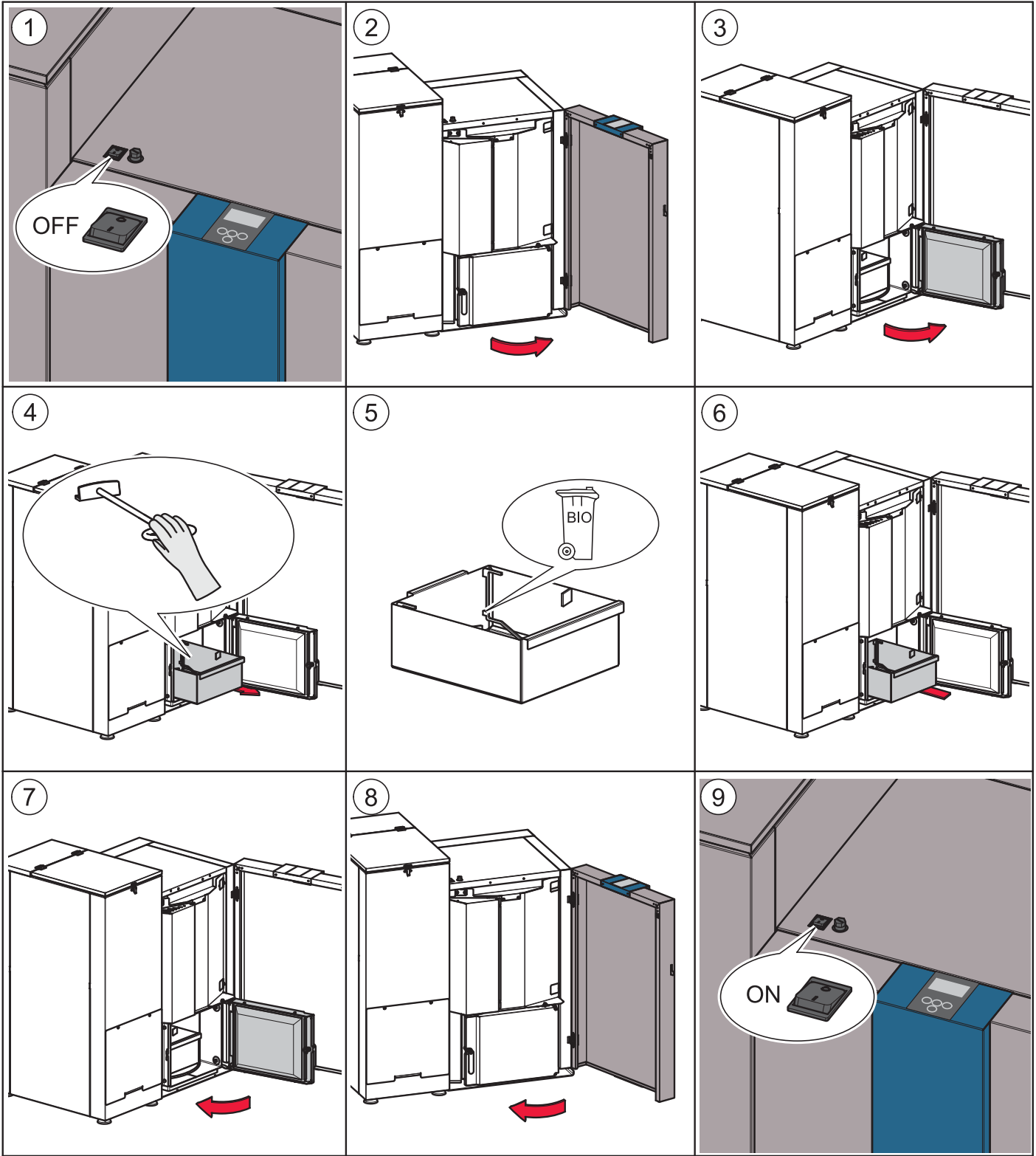

## 7.3 Cleaning the boiler every year

Boiler cleaning must be carried out once every heating season.



### **WARNING**

#### **Risk of burns**

Do not clean the boiler until it has been allowed to cool down.

Switch off the heating system at least 6 hours before opening the boiler.

Switch off the main switch before starting any maintenance work on the system.



### **CAUTION**

#### **Risk of cut injuries due to sharp edges**

Use gloves.

### Procedure for cleaning the boiler

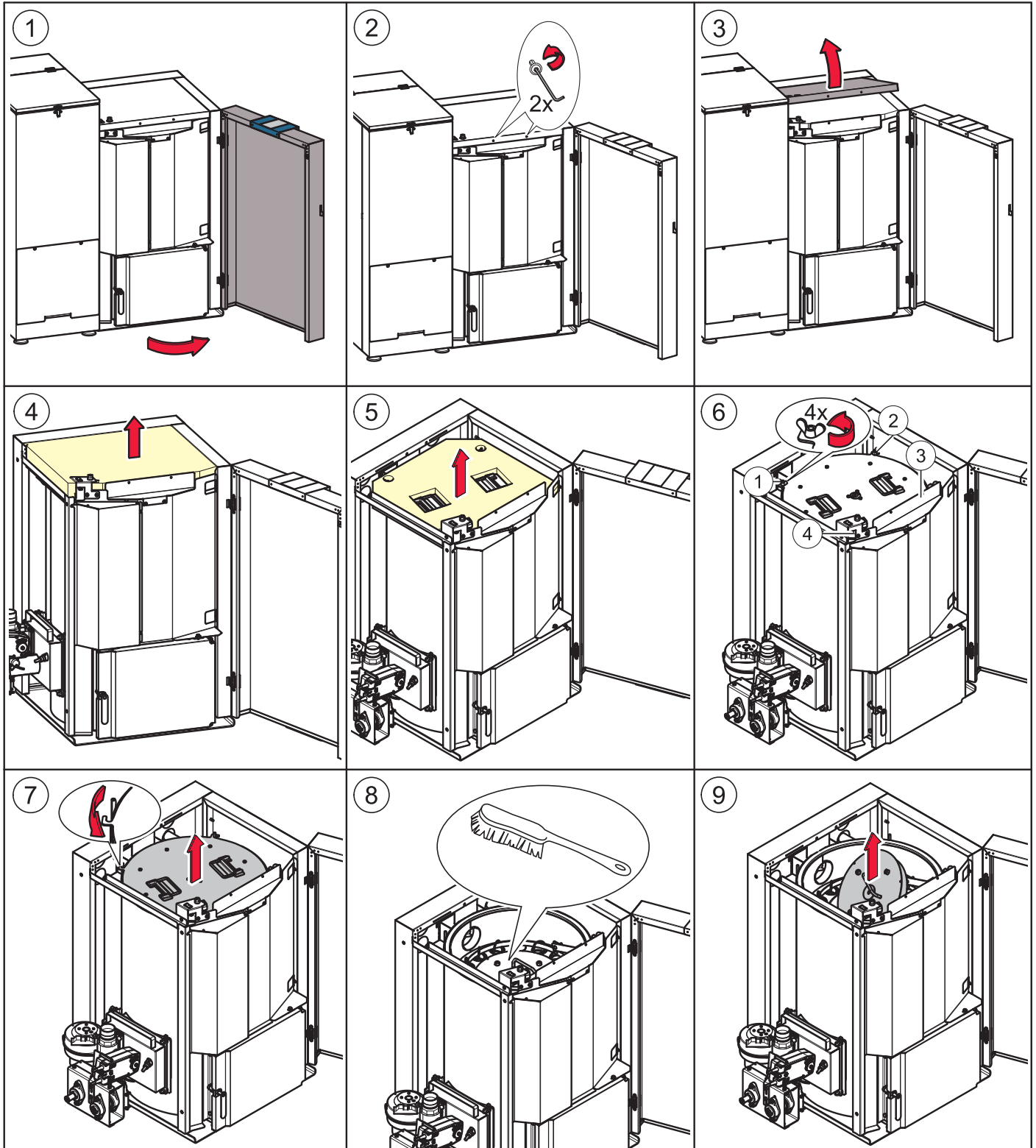
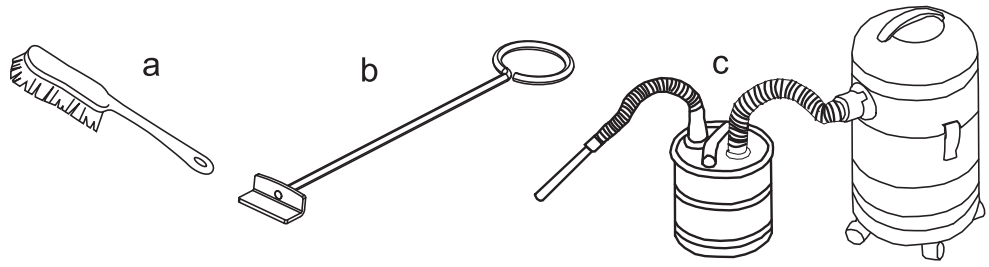
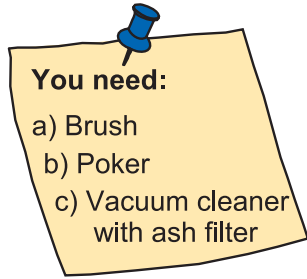



# NOTICE

Reduction in boiler performance and damage to pellet boiler due to blockages in the air inlet  
 Clean the air intakes, the burner plate and the flame tube.

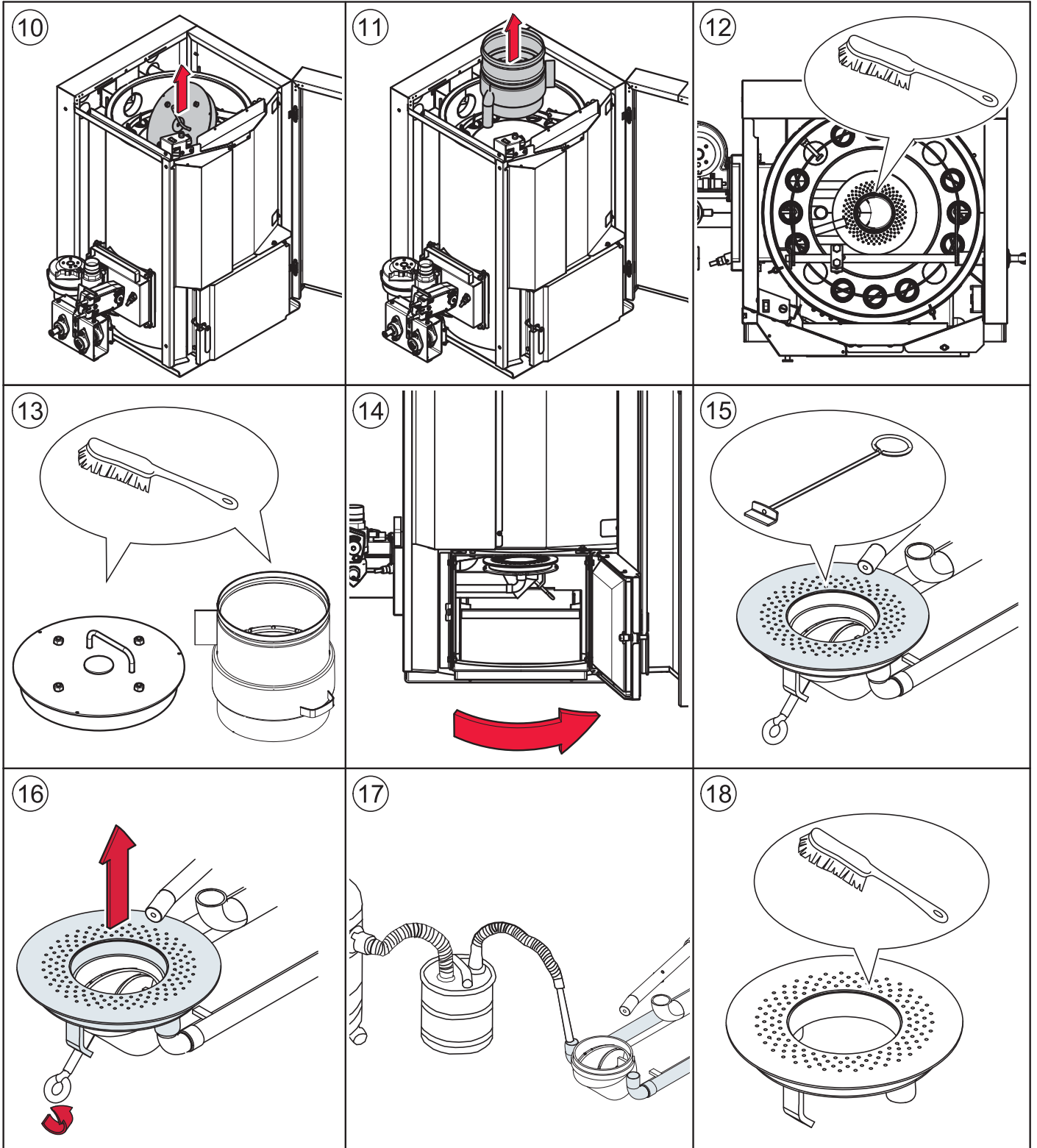

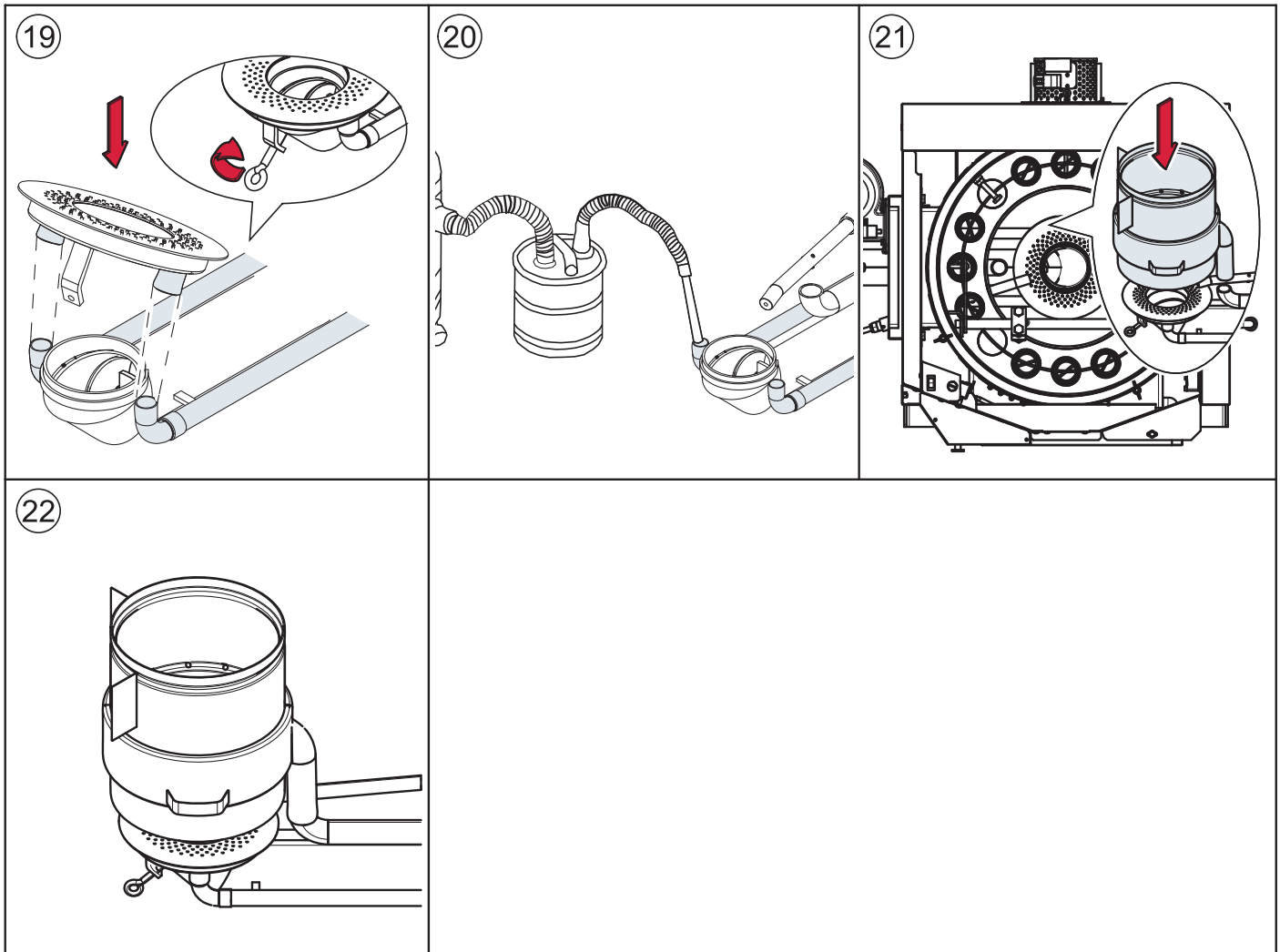

### Cleaning the Induced draft blower:

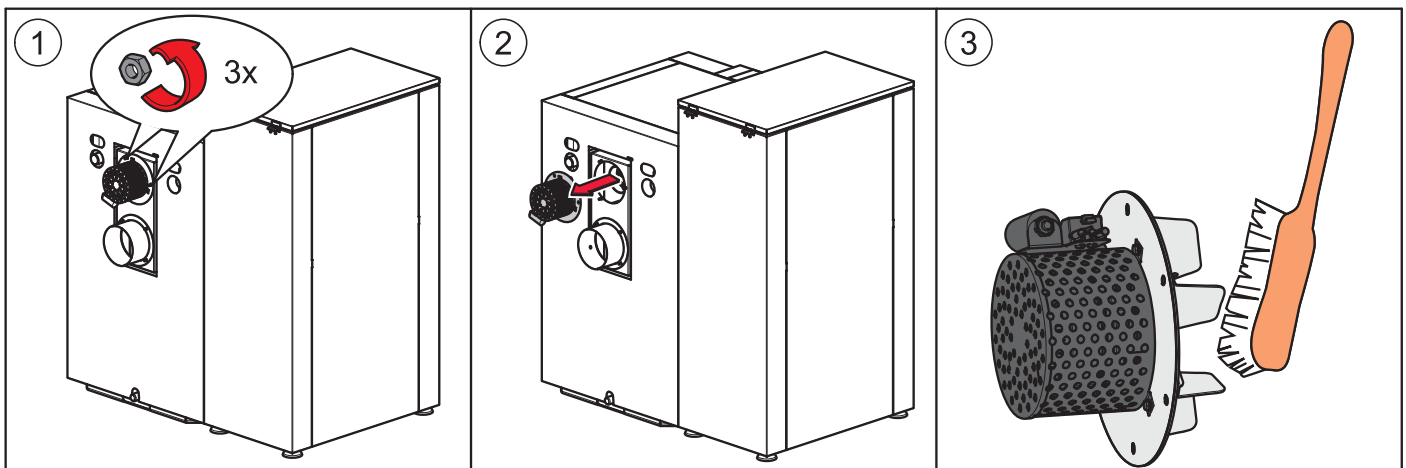

## 8 Operating the heating system

### NOTICE

Damage caused do to incorrect operation or incorrect settings.

Only trained operators may use the heating system. Make sure no unauthorised persons enter the central heating room. Keep children away from the central heating room and storage room.



### DANGER

Fire risk

Keep the ash removal door closed while the boiler is in operation.

### 8.1 Description of the control panel

The control panel is located in the boiler front cover.

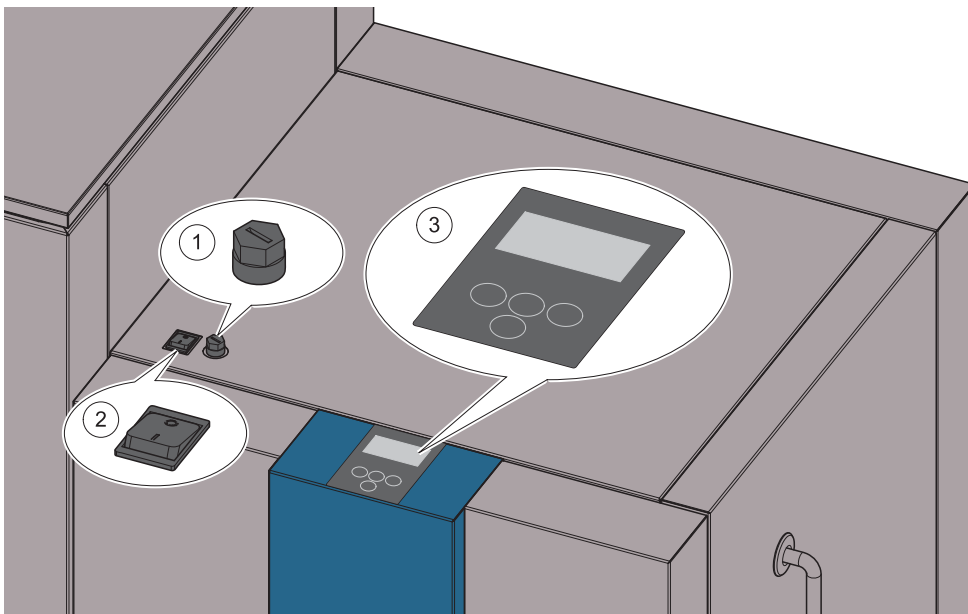

1	Safety temperature sensor	Switches the heating system off, if the boiler temperature reaches 95°C.
2	Main switch	Switches off the heating system (both poles) including the power supply to the control panel.
3	User control unit	Operates the boiler controller and the heating controller.

## 9 User controls and their function

### Navigation-icons



#### Icon-view

#### Description



Use the up arrow to return to the previous menu screen.



Use the down arrow to arrive at the next menu screen.



When this symbol is displayed, the set value can be changed. When this function is selected, the value can be changed by pressing the arrow keys.



When this function is selected, you leave the menu without saving the changed value.

### Icons System status

Icon-view	Description
	Run down time
	Heating full power
	Container cover is open
	OFF
	Ignition
	Boiler cleaning
	<b>Note:</b> This message appears when the container cover has been open for longer than 20 seconds.
	Warning

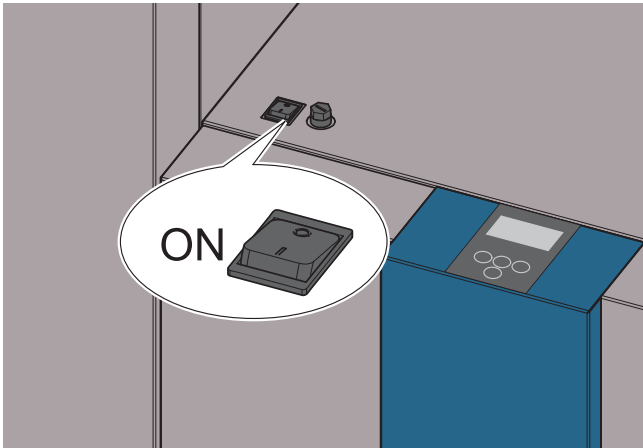

After switching on, the boiler starts (after approx. 10 seconds).  
The fire protection device is opened.

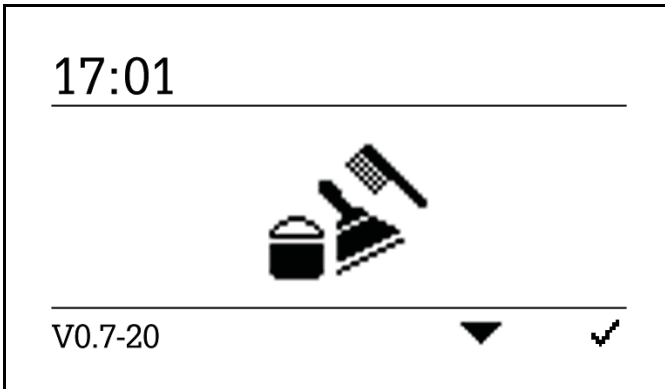

This symbol appears on the display while the fire protection device is being opened (approx. 2 minutes).

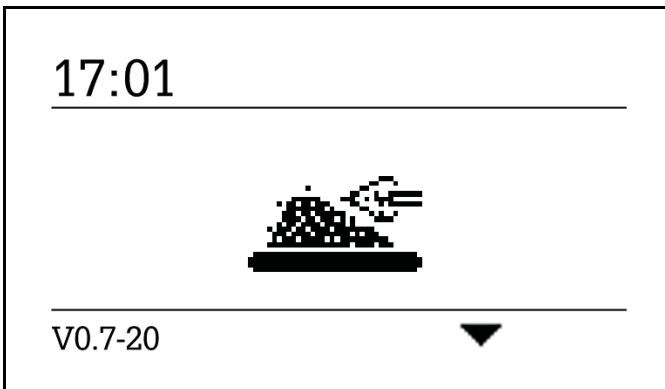

After the fire protection device has been opened, the ignition process starts and the symbol for ignition is displayed.

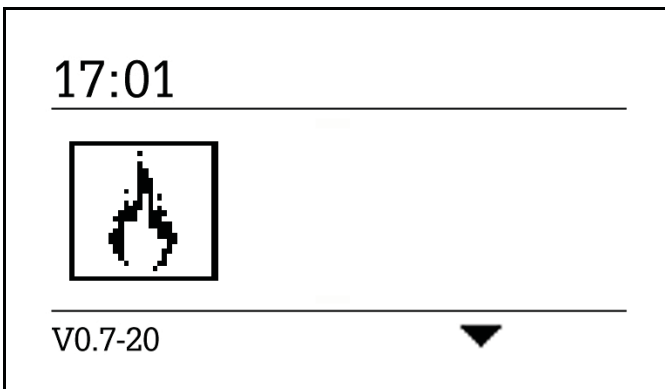

On completion of the ignition process (can last up to 15 minutes), the symbol for heating at full power appears. The boiler is now heating at full power.



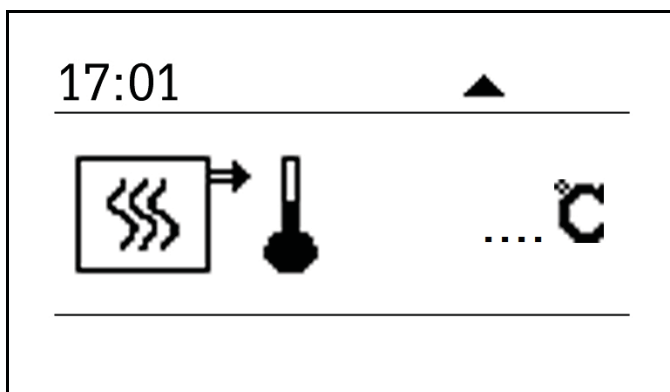

The current boiler temperature is displayed.



- button

## 9.1 Selecting the set DHW temperature

### Note:

This function is only available if a DHW sensor is connected to the boiler controller.

Please also refer to the installation manual, chapter 13, "**Controller for heating and hot water**".

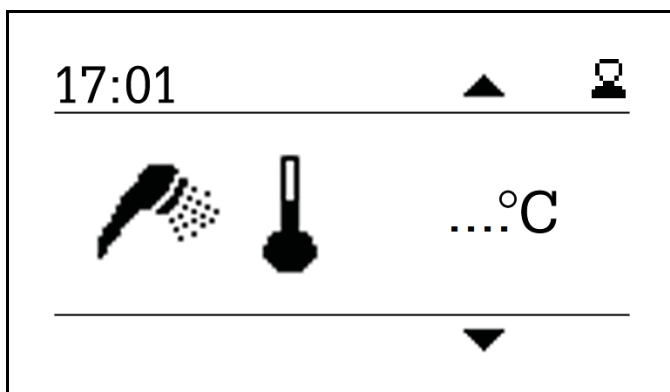

The current DHW temperature is displayed.



- button

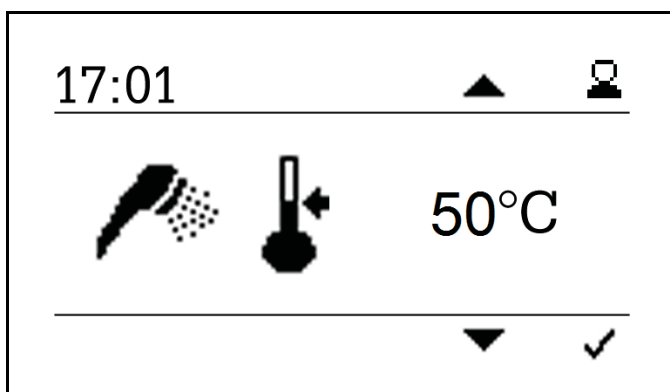

The set DHW temperature is displayed.  
Factory setting = 50° C

The set DHW temperature can be changed as follows:



- button

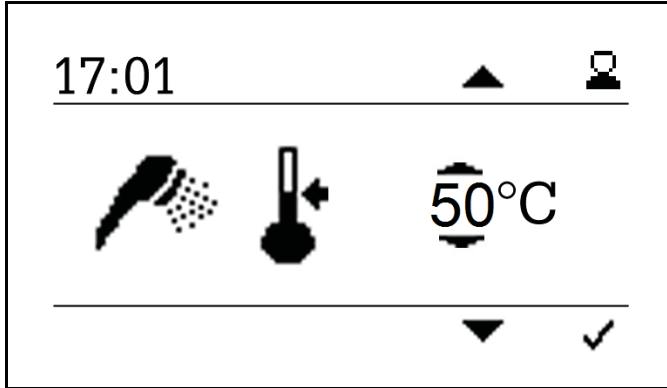

The value can be raised or lowered by pressing the keys



- button = save value

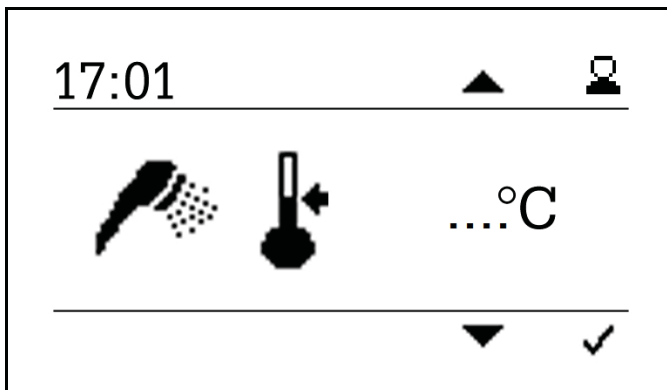

The stored value is displayed.



- button

### 9.1.1 Setting the time program for DHW heating

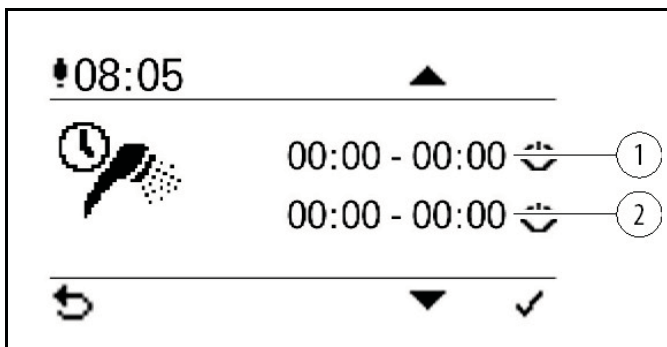

1. Heating period 1
2. Heating period 2



- button

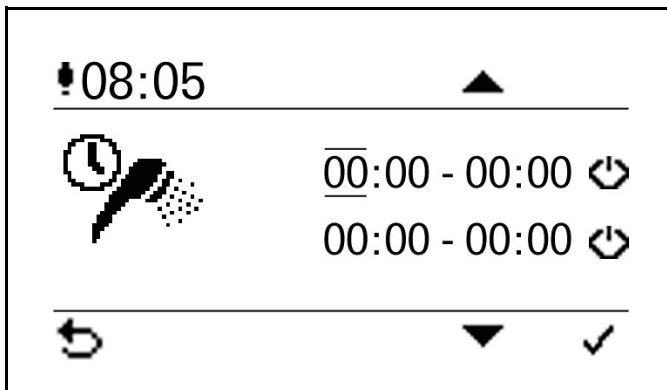

Cursor at the hour.



- button

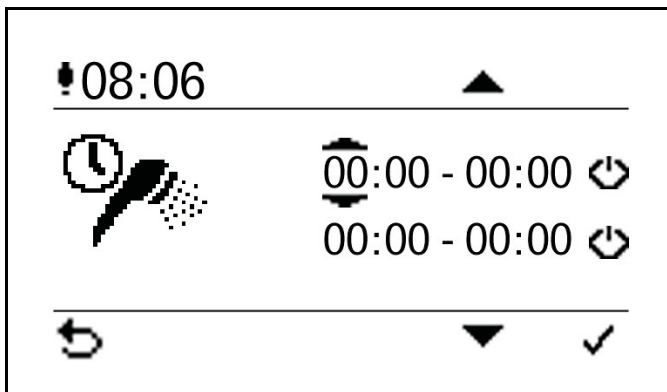

The value can be set by pressing the keys



- button = save value

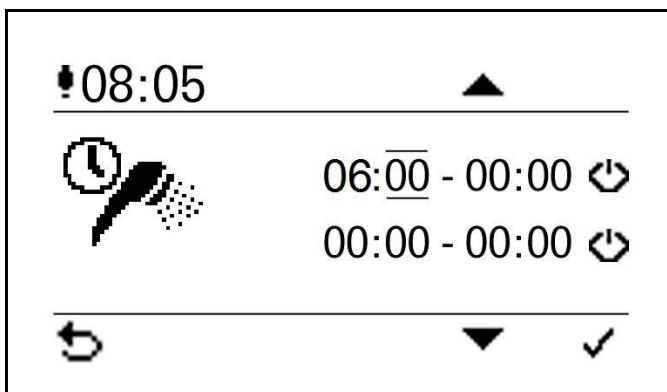

Cursor jumps to the minute.

Other values (minutes and hours) are set as described above.

**Note:**

The set heating period still needs to be activated.





- button

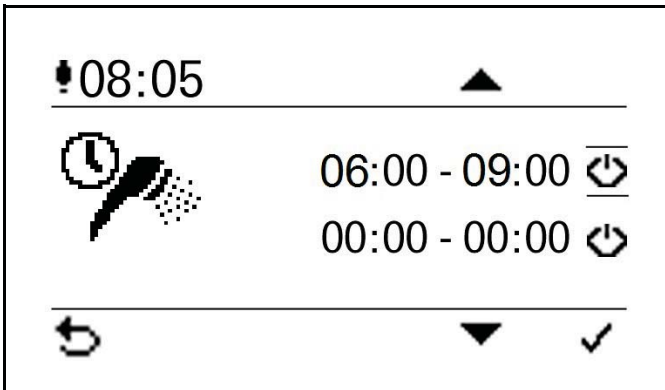

Cursor at the symbol



- button

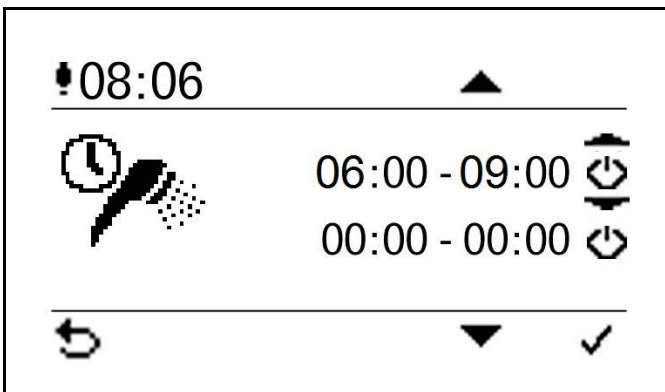

button = Activate the set heating periods.

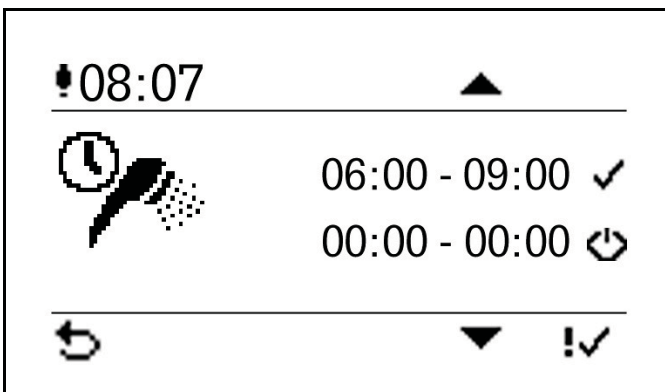

The symbol shows that the heating periods have been activated and saved.



- button

### 9.1.2 Setting the time

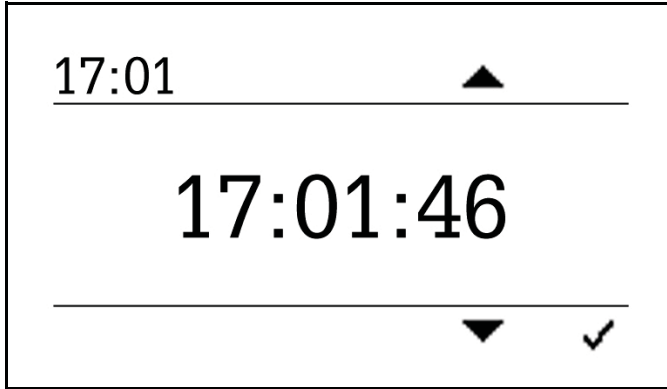

The current time is displayed.

**Note:**

The time is set in the same way as the heating periods!



- button

### 9.1.3 Status display

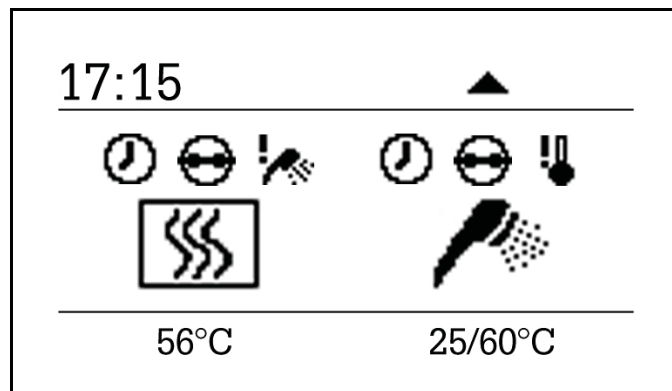







The current status is displayed.  
No settings can be entered.

This display is for information only.

Pressing the button  repeatedly returns you to the start screen.

#### Status display symbols:

Display	Description
	DHW priority active (heating circuit demand is subordinate).
	Pump output active.
	Minimum boiler temperature (pump release) has not been reached.
	Time program active.
	Burner demand via burner contact / thermostat.
	Warning

## 9.2 Setting the boiler heating period

### Note:

This function is only available if an external heating controller is used and no DHW sensor is connected to the boiler controller.

Please also refer to the installation manual, chapter 13, "**Controller for heating and hot water**"

If heating periods are programmed, the boiler runs at the set times.

During these periods, burner requests from the external controller (terminal 7/8) are ignored.

Outside the programmed heating periods, burner demand from the external controller (terminal 7/8) is active again.

### Note:

Programming of heating periods is NOT advisable if an external controller is used!

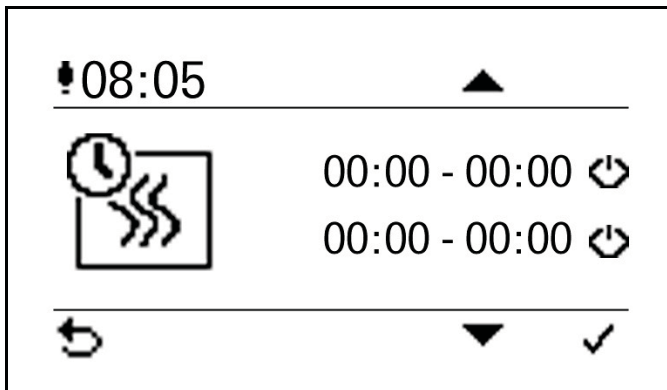

- button

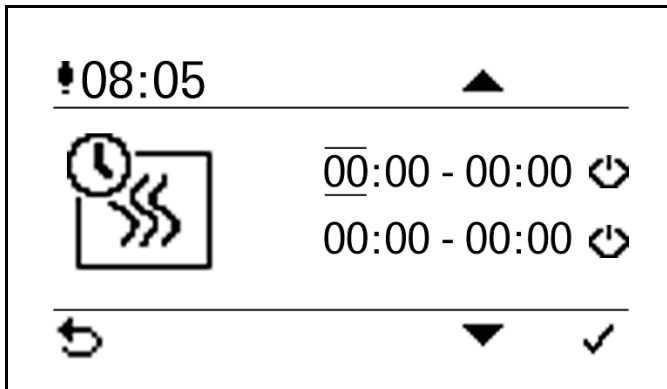

Cursor at the hour.



- button

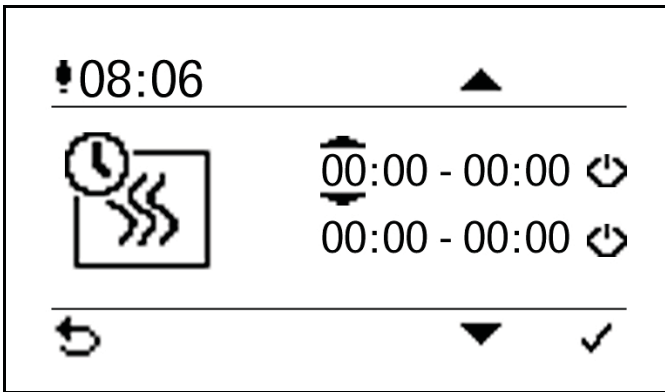

The value can be set by pressing the keys  / .



- button = save value

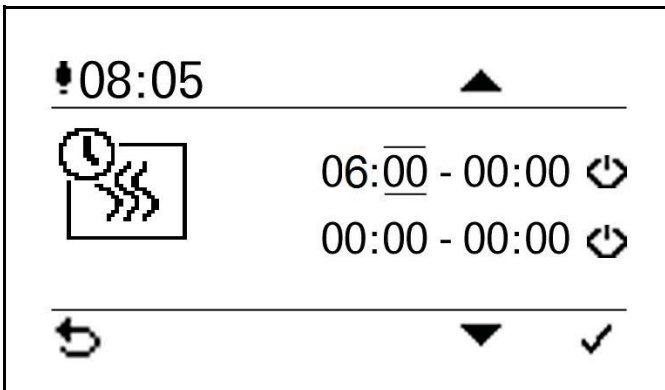

Cursor jumps to the minute.

Other values (minutes and hours) are set as described above.

**Note:**

The set heating period still needs to be activated.



- button

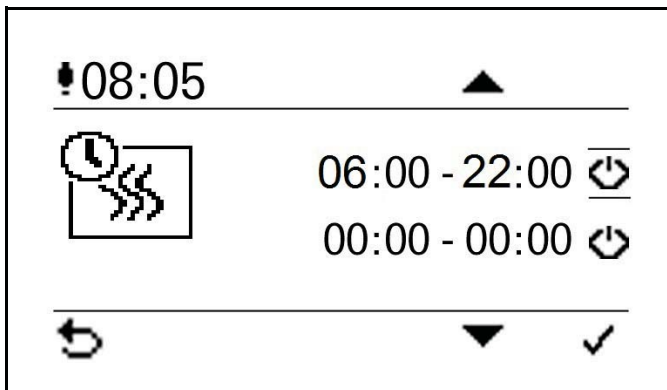

Cursor at the symbol



- button

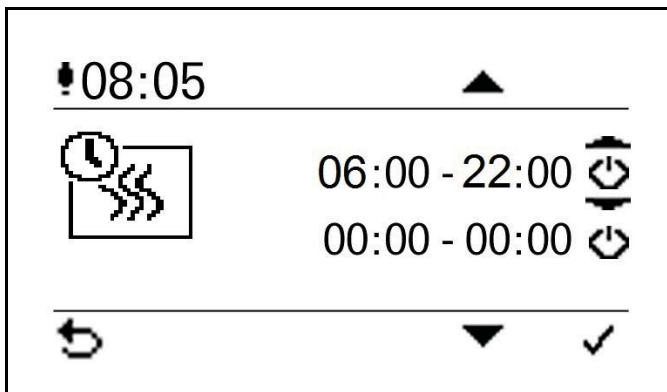

button = Activate the set heating periods.

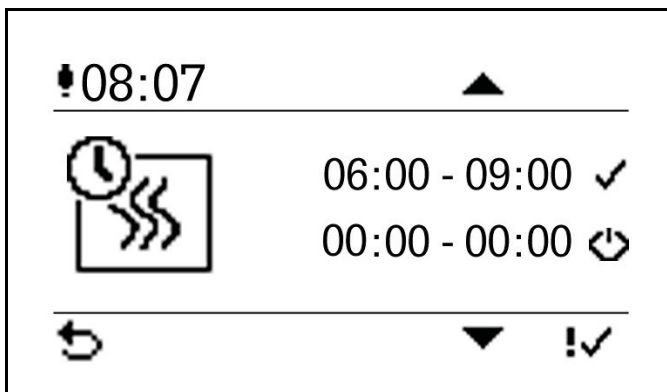

The symbol shows that the heating periods have been activated and saved.



- button

### 9.2.1 Setting the time



The current time is displayed.

**Note:**

The time is set in the same way as the heating periods!



- button

### 9.2.2 Status display

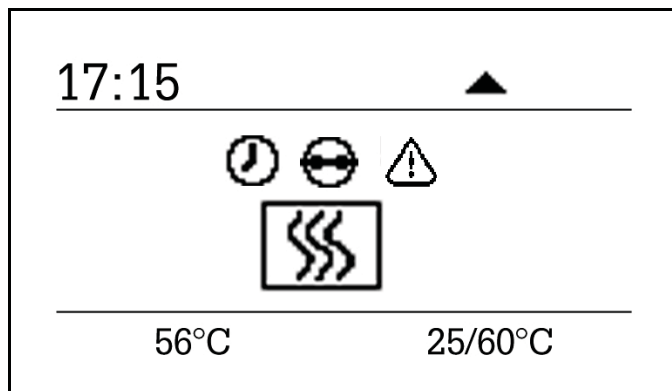





The current status is displayed.  
No settings can be entered.

This display is for information only.

Pressing the button  repeatedly returns you to the start screen.

#### Status display symbols:

Display	Description
	Pump output active.
	Minimum boiler temperature (pump release) has not been reached.
	Time program active.
	Burner demand via burner contact / thermostat.
	Warning



# 10 Malfunctions

## 10.1 Malfunctions - what to do

Follow the sequence described for handling malfunctions.

- The heating system switches off automatically if a malfunction occurs.
- The control unit display shows a malfunction alarm text.
- You have to rectify the cause of the malfunction.
- After eliminating the underlying causes, you can restart the boiler.

## 10.2 Fault texts

The fault text displayed on the screen provides information on the type and status of the malfunction as well as help for troubleshooting.

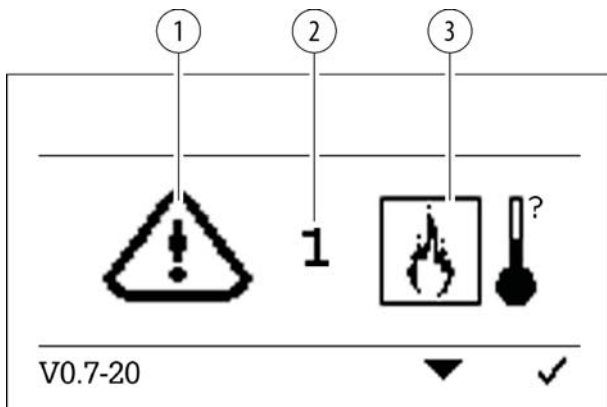

1. Warning symbol
2. Error code
3. Error symbol

**Note:**

The system restarts automatically when the cause has been eliminated.

**Overview of malfunction alarm texts:**

Display:			
Error code:	0		
Description:	Boiler sensor fracture, measuring circuit from boiler sensor is open		
Cause and Remedy:	sensor not connected	▶	connect sensor at input
	sensor defect	▶	measure sensor (approx. 2kΩ at 25° C) replace if required
	sensor cable defect	▶	replace sensor
	sensor temperature too high	▶	sensor temperature above measuring range (1100° C)
Description:	Boiler sensor short circuit, measuring circuit from boiler sensor is shorted out		
Cause and Remedy:	sensor defect	▶	measure sensor (approx. 2kΩ at 25° C) replace if required
	sensor cable defect	▶	replace sensor
	sensor temperature too low	▶	sensor temperature below measuring range (-10° C)

Display:		
Error code:	1, 2, 3	
Description:	Combustion chamber sensor fracture, measuring circuit from combustion chamber sensor is open	
Cause and Remedy:	sensor not connected	▶ connect sensor at input
	sensor defect	▶ Measure sensor (approx. 5mV at 125° C) replace if required
	sensor cable defect	▶ replace sensor
	sensor temperature too high	▶ sensor temperature above measuring range (1100° C)
Description:	Combustion chamber sensor short-circuit, measuring circuit from combustion chamber sensor is shorted out	
Cause and Remedy:	sensor defect	▶ Measure sensor (approx. 5mV at 125° C) replace if required
	sensor cable defect	▶ replace sensor
	sensor temperature too low	▶ sensor temperature below measuring range (-10° C)
	sensor polarity incorrect	▶ exchange + and - connections

Display:		
Error code:	4	
Description:	Negative draft input open, measuring circuit from negative draft measurement open	
Cause and Remedy:	signal incorrect	▶ check polarity and signal (0-10V)
	signal cable defect	▶ replace sensor
	signal too low	▶ signal below 0V
	combustion chamber leak	▶ check closure of boiler door
Error code:	5	
Description:	Negative draft input short-circuit, measuring circuit from negative draft measurement is shorted out	
Cause and Remedy:	signal incorrect	▶ check polarity and signal (0-10V)
	signal cable defect	▶ replace sensor
	signal too high	▶ signal above 10V
Error code:	6	
Description:	Negative draft pressure in boiler is not achieved	
Cause and Remedy:	negative draft tube disconnected	▶ connect up negative draft tube

	negative draft does not change	▶	Check negative draft tube for leaks. Check flue gas tube for blockage.
	Negative draft pressure too low	▶	Close boiler door, check tube to negative draft sensor, check whether boiler flue gas outlet is clear, check whether condensation heat exchanger is clear. Make sure flue gas fan is running.

Display:			
Error code:	7		
Description:	Safety temperature limiter has tripped		
Cause and Remedy:	safety temperature limiter unplugged	▶	connect up safety temperature limiter and check cable connections
	safety temperature limiter has tripped	▶	check boiler controller
	safety temperature limiter defect	▶	allow boiler to cool and reset alarm

Display:			
Error code:	8, 9		
Description:	Flue gas minimum temperature not reached during ignition phase		
Cause and Remedy:	no pellets available	▶	fill up with pellets
	ignition electrode defect	▶	check ignition electrode (approx. 200Ω) replace if required
	ignition nozzle blocked	▶	clean burner plate and ignition tube
	flue gas sensor contaminated	▶	clean flue gas sensor and flue gas tube
	flue gas sensor is not in flue gas tube	▶	insert flue gas sensor into flue gas tube

Display:			
Error code:	10		
Description:	Flame return gate open fault.		
Cause and Remedy:	flame return gate unplugged	▶	Connect up flame return gate and check cable connections
	Flame return gate does not reach OPEN limit switch	▶	check ball valve to see if it is jammed
	no signal although open	▶	check cables and flame return gate
Error code:	11		

Description:	Flame return gate closed fault.		
Cause and Remedy:	flame return gate unplugged	▶	Connect up flame return gate and check cable connections
	Flame return gate does not reach CLOSE limit switch	▶	check whether ball valve is jammed, check ball valve throughway to see if foreign objects are preventing it from closing
	no signal although closed	▶	check cables and flame return gate
Error code:	12		
Description:	Both flame return gate limit switches are closed at the same time		
Cause and Remedy:	both limit switches activated	▶	check flame return gate, check cables, check connectors

Display:			
Error code:	14		
Description:	Container cover open		
Cause and Remedy:	Cover open	▶	close cover
	End-switch defect	▶	replace end-switch

Display:			
Error code:	15		
Description:	DHW sensor fracture, measuring circuit from DHW sensor is open		
Cause and Remedy:	sensor not connected	▶	connect sensor at input
	sensor defect	▶	measure sensor (approx. 2kΩ at 25° C) replace if required
	sensor cable defect	▶	replace sensor
	sensor temperature too high	▶	sensor temperature above measuring range (1100° C)
Description:	DHW sensor short circuit, measuring circuit from boiler sensor is shorted out		
Cause and Remedy:	sensor defect	▶	measure sensor (approx. 2kΩ at 25° C) replace if required
	sensor cable defect	▶	replace sensor
	sensor temperature too low	▶	sensor temperature below measuring range (-10° C)

## 10.3 Maintenance intervals

Eco Engineering recommends regular/annual maintenance by an Eco Engineering service technician or an authorized partner.

The volume of maintenance beyond the cleaning of the boiler also contains for example a check of equipment, components and safety systems, if necessary the adaption of adjustments, trial operation and production of a maintenance report.

In some European countries there are legal obligations applying to maintenance intervals and emission measuring.

Contact your authorised dealer.

Eco Engineering recommends taking out a maintenance contract with your service technician.

## 10.4 Repairs



Only authorised specialists may carry our repair work on this system. Use original Eco Engineering spare parts only. Not using original Eco Engineering spare parts will cause the warranty to become void.

## 10.5 Checking the central heating room and storage room

Checking the pellet heating system regularly prevents malfunctions and unexpected failure of the heating system.

### Central heating room

Make sure that no flammable materials are stored in the central heating room.

Make sure that no washing is hanging in the central heating room.

Check the display at the control panel for malfunction messages.

Check the flue gas tube and chimney. Let them clean regularly (at least once per year).

### Storage room



**DANGER**

#### Risk of suffocation

Ventilate the pellet storage room sufficiently before entering.

Switch off the heating system before entering.

Check the level of pellets in the pellet storage room or fabric tank and order more pellets in good time.





Distributed in UK by:

**Organic Energy (UK) Ltd**

Severn Road, Welshpool

Powys, SY21 7AZ

Tel. 01938 530 070

mail: [info@organicenergy.co.uk](mailto:info@organicenergy.co.uk)

[www.organicenergy.co.uk](http://www.organicenergy.co.uk)

